

Introduction to HPC Using zcluster at GACRC

Georgia Advanced Computing Resource Center

University of Georgia

Suchitra Pakala

pakala@uga.edu

Slides courtesy: Zhoufei Hou

OVERVIEW

- ❖ GACRC
- ❖ High Performance Computing (HPC)
- ❖ zcluster – Architecture, Operation
- ❖ Access and Working with zcluster

Georgia Advanced Computing Resource Center

Who Are We?

- ❖ Georgia Advanced Computing Resource Center (**GACRC**)
- ❖ Collaboration between the Office of Vice President for Research (**OVPR**) and the Office of the Vice President for Information Technology (**OVPIIT**)
- ❖ Guided by a faculty advisory committee (GACRC-AC)

Why Are We Here?

- ❖ To provide computing hardware and network infrastructure in support of high-performance computing (**HPC**) at UGA

Where Are We?

- ❖ <http://gacrc.uga.edu> (Web) <http://wiki.gacrc.uga.edu> (Wiki)
- ❖ <http://gacrc.uga.edu/help/> (Web Help)
- ❖ https://wiki.gacrc.uga.edu/wiki/Getting_Help (Wiki Help)

GACRC Users September 2015

Colleges & Schools	Depts	PIs	Users
Franklin College of Arts and Sciences	14	117	661
College of Agricultural & Environmental Sciences	9	29	128
College of Engineering	1	12	33
School of Forestry & Natural Resources	1	12	31
College of Veterinary Medicine	4	12	29
College of Public Health	2	8	28
College of Education	2	5	20
Terry College of Business	3	5	10
School of Ecology	1	8	22
School of Public and International Affairs	1	3	3
College of Pharmacy	2	3	5
	40	214	970
Centers & Institutes	9	19	59
TOTALS:	49	233	1029

GACRC Users September 2015

Centers & Institutes	PIs	Users
Center for Applied Isotope Study	1	1
Center for Computational Quantum Chemistry	3	10
Complex Carbohydrate Research Center	6	28
Georgia Genomics Facility	1	5
Institute of Bioinformatics	1	1
Savannah River Ecology Laboratory	3	9
Skidaway Institute of Oceanography	2	2
Center for Family Research	1	1
Carl Vinson Institute of Government	1	2
	19	59

Computer Cluster

- ❖ Cluster is a widely used term meaning independent computers combined into a unified system through software and high speed dedicated network
 - ❖ It provides greater computational power than a single computer can provide – LARGER problems can be solved
- ❖ Used for:
 - ❖ High Availability (HA)
 - ❖ Greater reliability
 - ❖ High Performance Computing (HPC)

High Performance Computing (HPC)

Several “definitions” can be found, but, in general:

Use of Parallel processing for solving complex computational problems using advanced application programs efficiently, reliably and quickly

High Performance Computing (HPC)

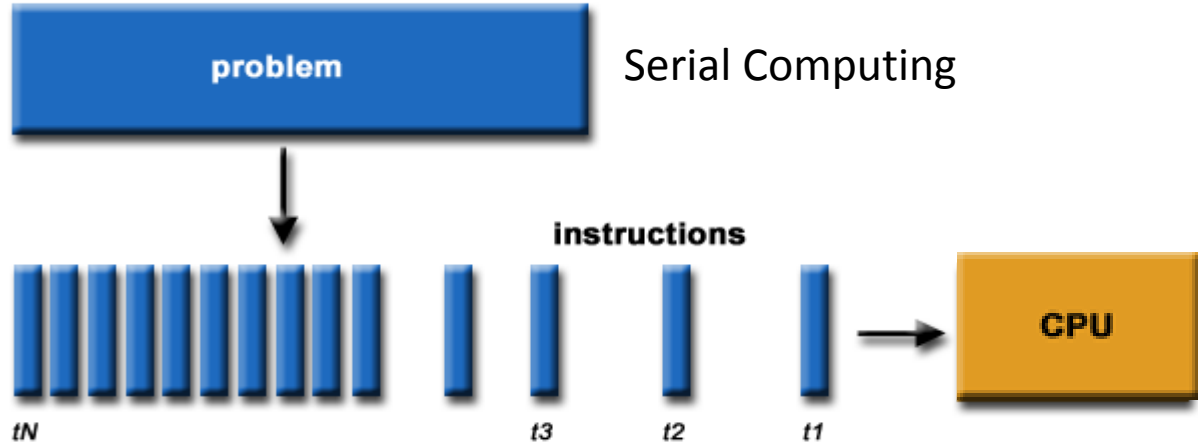

Serial Computing

- ❖ A problem is broken into a discrete series of instructions
- ❖ Instructions are executed sequentially
- ❖ Executed on a single processor
- ❖ Only one instruction may execute at any moment in time

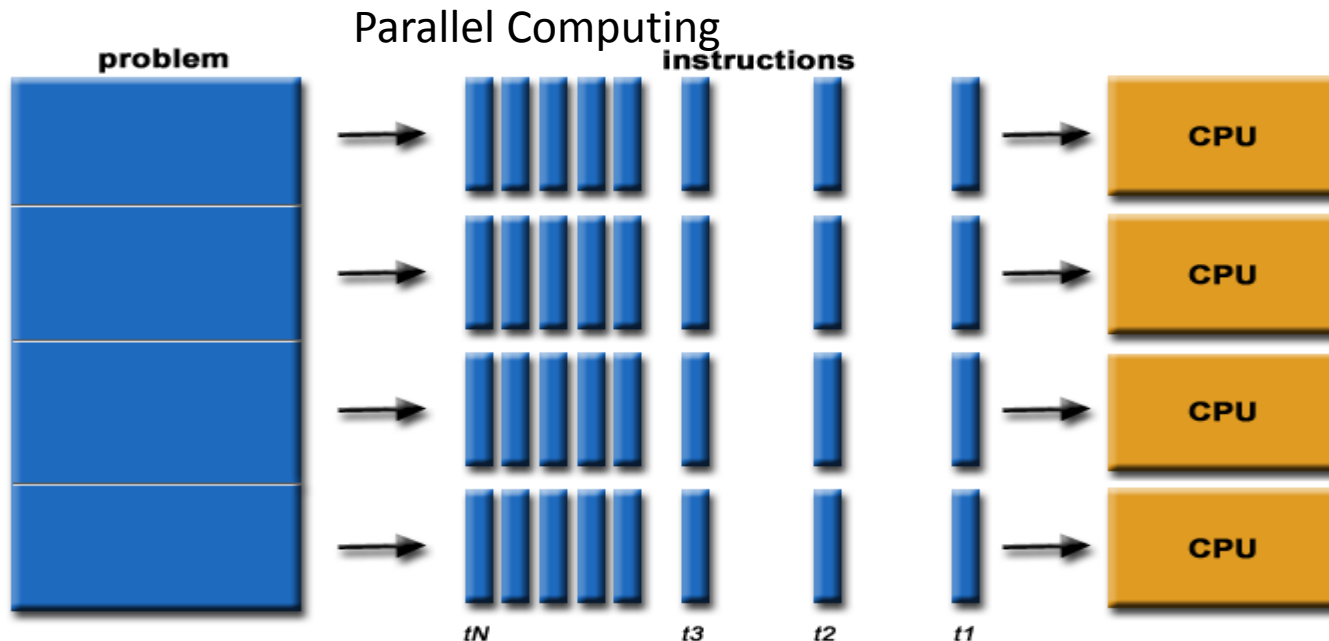

Parallel Computing

- ❖ A problem is broken into discrete parts that can be solved concurrently
- ❖ Each part is further broken down to a series of instructions
- ❖ Instructions from each part execute simultaneously on different processors
- ❖ An overall control/coordination mechanism is employed

Zcluster Overview

- ❖ zcluster Structure
- ❖ General Information
- ❖ Computing Resources
- ❖ Storage Environment

GACRC Linux HPC Zcluster Structural Diagram

Zcluster Connection Speed :

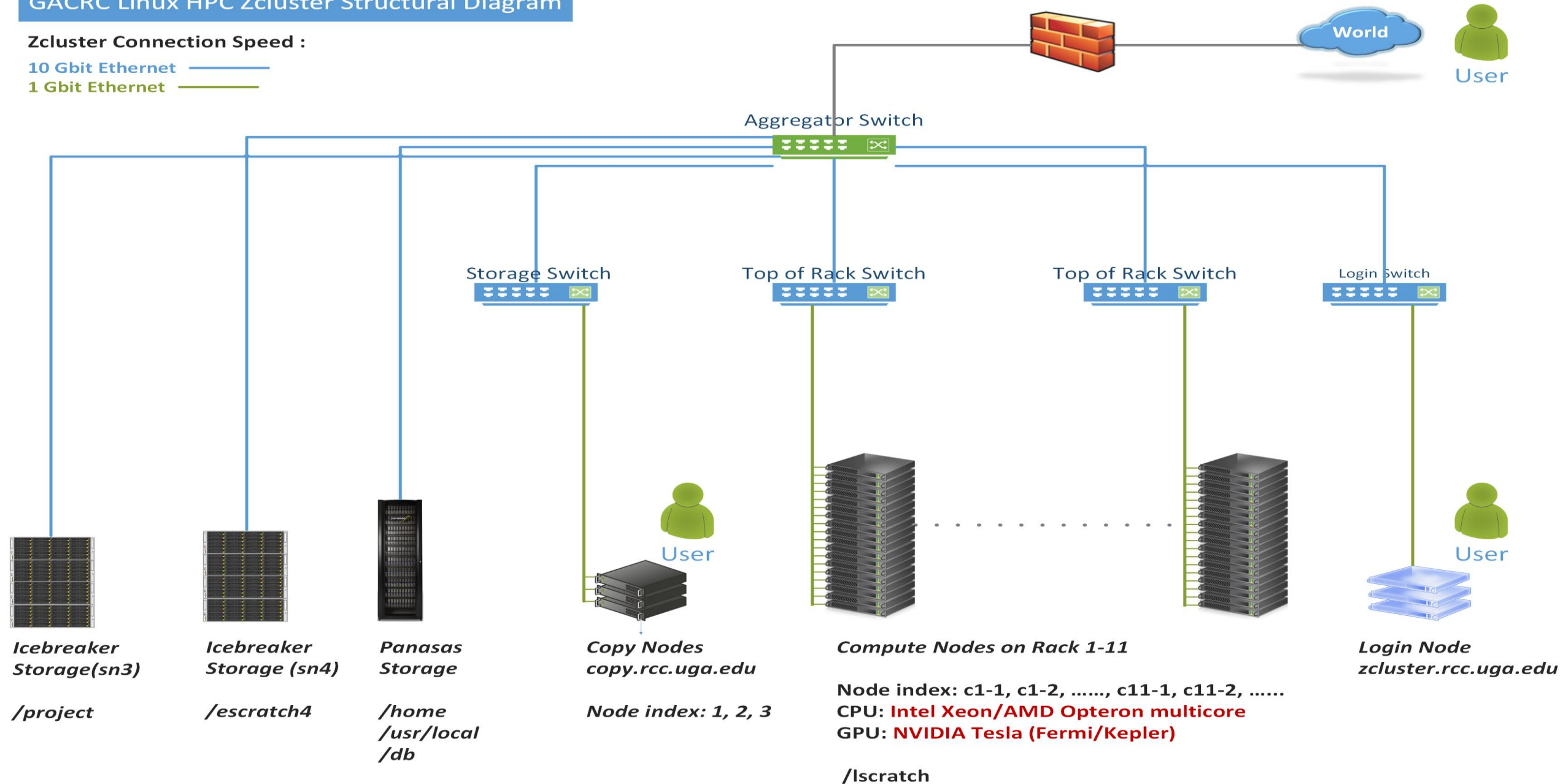

10 Gbit Ethernet 

1 Gbit Ethernet 



zcluster – General Information

GACRC zcluster is a Linux high performance computing (HPC) cluster:

- ❖ Operating System: **64-bit Red Hat Enterprise Linux 5 (RHEL 5)**
- ❖ Login Node: **zcluster.rcc.uga.edu**
zcluster.rcc.uga.edu ^{qlogin}  Interactive Node: **compute-14-7/9**
- ❖ Copy Node: **copy.rcc.uga.edu**
- ❖ Internodal Communication: **1Gbit** network
 - compute nodes  compute nodes
 - compute nodes  storage systems

NOTE: Please Do Not run jobs on the zcluster login node - use the Queues or the Interactive Nodes.

zcluster – General Information

- ❖ Batch-queueing System:
 - ❖ Jobs can be started (submitted), monitored, and controlled
 - ❖ Determine which compute node is the best place to run a job
 - ❖ Determine appropriate execution priority for a job to run
- ❖ On zcluster: **Sun Grid Engine (SGE)**



zcluster – Computing Resources

Queue Type	Queue Name	Nodes	Processor	Cores/Node	RAM(GB)/Node	Cores	NVIDIA GPU
Regular	rcc-30d	45	Intel Xeon	12	48	540	N/A
		150		8	16	1200	
High Memory	rcc-m128-30d	1	Intel Xeon	8	128	8	N/A
		4		8	192	32	
		10		12	256	120	
	rcc-m512-30d	2		32	512	64	
Multi Core	rcc-mc-30d	6	AMD Opteron	32	64	192	N/A
Interactive	interq	2	AMD Opteron	48	132	96	N/A
GPU	rcc-sgpu-30d	2	Intel Xeon	8	48	16	4 Tesla S1070 cards
	rcc-mgpu-30d	2		12	48	24	9 Tesla (Fermi) M2070 cards
	rcc-kgpu-30d	4		12	96	24	32 Tesla (Kepler) K20Xm cards

Total peak performance: 23 Tflops

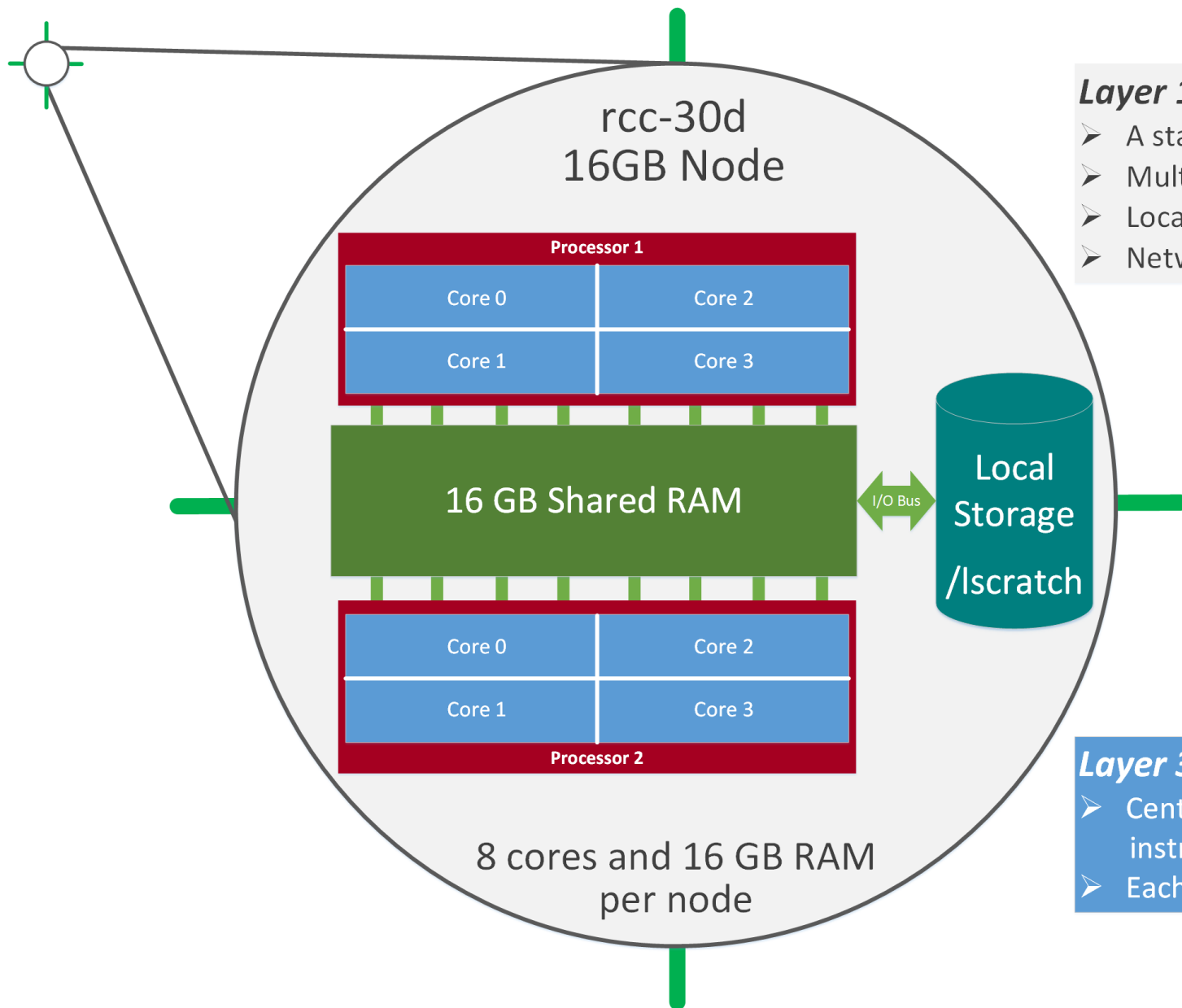

Layer 1: Node

- A standalone “computer in a box”
- Multiple processors, e.g. 2, sharing memory
- Local disk storage, network interface, etc.
- Networked into a cluster

Layer 2: Processor

- A single computing component
- Multicore processor, e.g. 4 cores

Layer 3: Core

- Central processing unit (CPU) reading and executing instructions independently
- Each core is assigned to a software thread

zcluster – Storage Environment

- ❖ Mainly, there are 4 different storage locations:
 - ❖ **Home directory** - where you would land after logging in to the zcluster
 - ❖ **lscratch** - is the storage that is local to the computation nodes
 - ❖ **escratch4** - is temporary scratch which is visible to all nodes
 - ❖ **Project** storage area - is long term, and is created for a lab.

zcluster – Storage Environment

- ❖ **Home directory** → */home/groupname/username*
- ❖ Mounted and visible on **all nodes**, with a quota of **~100GB**
- ❖ Any directory on /home has **snapshot** backups
 - ❖ Taken once a day, and maintained **4 daily** ones and **1 weekly** one
 - ❖ Name: **.snapshot**, e.g., /home/abclab/jsmith/.snapshot
 - ❖ **Completely invisible**, however, user can “cd” into it and then “ls”:

```

pakala@zcluster:~$ pwd
/home/rccstaff/pakala
pakala@zcluster:~$ ls -a
.          .bash_history.compute-14-7  .bash_history.zhead  .bashrc          cmd_kill  .java  RNA_SEQ
..         .bash_history.compute-14-9  .bash_logout        batchsub_demo    e4        .mozilla  .ssh  → .snapshot is NOT
.bash_history  .bash_history.zcluster    .bash_profile      Blast           .emacs   ncbidb  .viminfo  shown here!
pakala@zcluster:~$ cd .snapshot  → Can “cd” into “.snapshot”
pakala@zcluster:~/ .snapshot$ ls  → And “ls” to list its contents
2015.11.29.00.00.01.weekly  2015.12.06.00.00.01.weekly  2015.12.07.01.00.01.daily  2015.12.09.01.00.01.daily
2015.12.05.01.00.01.daily  2015.12.06.01.00.01.daily  2015.12.08.01.00.01.daily
  
```

zcluster – Storage Environment

- ❖ **Local scratch** → `/lscratch/username`
 - ❖ On **local disk** of each **compute** node → **node-local storage**
 - ❖ rcc-30d 8-core nodes: **~18GB**, rcc-30d 12-core nodes: **~370GB**
 - ❖ **No snapshot backup**
 - ❖ Usage Suggestion: *If your job writes results to /lscratch, job submission script should move the data to your home or escratch before exit*
- ❖ **Ephemeral Scratch** → `/escratch4/pakala/pakala_Nov_13`
 - ❖ Create with `make_escalch` command
 - ❖ Visible to **all nodes** with a quota of **4TB**
 - ❖ **No snapshot backup**
 - ❖ To be deleted after **37 days**

zcluster – Storage Environment

Filesystem	Role	Quota	Accessible from	Intended Use	Notes
/home/abclab/username	Home	100GB	zcluster.rcc.uga.edu (Login)	Highly static data being used frequently	Snapshots
/escratch4/username	Scratch	4TB	copy.rcc.uga.edu (Copy) Interactive nodes (Interactive) compute nodes (Compute)	Temporarily storing large data being used by jobs	Auto-deleted in 37 days
/lscratch/username	Local Scratch	18 ~ 370GB	Individual compute node	Jobs with heavy disk I/O	User to clean up
/project/abclab	Storage	Variable	copy.rcc.uga.edu (Copy)	Long-term data storage	Group sharing possible

- Note:
1. /usr/local : Software installation directory
/db : bioinformatics database installation directory
 2. To login to [Interactive](#) nodes, use [qlogin](#) from [Login](#) node

zcluster – Storage Environment

6 Main Function	On/From-Node	Related Filesystem
Login Landing	Login or Copy	/home/abclab/username (Home) (Always!)
Batch Job Submitting	Login or Interactive	/escratch4/username (Scratch) (Suggested!) /home/abclab/username (Home)
Interactive Job Running	Interactive	/escratch4/username (Scratch) /home/abclab/username (Home)
Data Archiving , Compressing and Transferring	Copy	/escratch4/username (Scratch) /home/abclab/username (Home)
Job Data Temporarily Storing	Compute	/lscratch/username (Local Scratch) /escratch4/username (Scratch)
Long-term Data Storing	Copy	/project/abclab

How does zcluster operate?

← 1 Gbit Ethernet →

Queueing System
Sun Grid Engine (SGE)

Login Node
zcluster.rcc.uga.edu
(login, job submission, text editing)



qlogin



Interactive Node
Queueing System
Sun Grid Engine (SGE)



Copy Node
copy.rcc.uga.edu
(data transferring, compression)



Longer-term data storage:
1. Lifecycle too long for /escratch4
2. Size too big for /home



Zcluster – Tips, Dos and Don'ts

Before we start:

- ❖ To get zcluster to be your best HPC buddy, go to **GACRC Wiki** (<http://wiki.gacrc.uga.edu>)
GACRC Web (<http://gacrc.uga.edu>)
- ❖ To get the most effective and qualified support from us, go to **GACRC Support** (https://wiki.gacrc.uga.edu/wiki/Getting_Help)
- ❖ To work happily and productively, follow the cluster's Community Code of Conduct (**CCOC**)

zcluster – Tips, Dos and Don'ts - continued

- Cluster's CCOC:

On cluster, you are not alone... Each user is sharing finite resources, e.g., CPU cycles, RAM, disk storage, network bandwidth, with other researchers.

What you do may affect other researchers on the cluster.

6 rules of thumb to remember:

- ❖ NO jobs running on login node
- ❖ NO multi-threaded job running with only 1 core requested
- ❖ NO large memory job running on regular nodes
- ❖ NO long job running on interactive node
- ❖ NO small memory job running on large memory nodes
- ❖ Use the copy node for file transfer and compression



How to work with zcluster? - Overview

- ❖ Start with zcluster
- ❖ Connect & Login
- ❖ Transfer Files
- ❖ Run Interactive Jobs
- ❖ Submit Batch Jobs
 - ❖ How to submit *serial*, *threaded*, and *MPI* batch jobs
 - ❖ How to check job status, cancel a job, etc.
- ❖ Software Installed

Getting Started with zcluster

- ❖ You need a **User Account** : username@zcluster.rcc.uga.edu
- ❖ Procedure: https://wiki.gacrc.uga.edu/wiki/User_Accounts
- ❖ User receives an email notification once the account is ready
- ❖ User can use `passwd` command to change initial temporary password
- ❖ A UGA faculty member (**PI**) may register a computing lab:
<http://help.gacrc.uga.edu/labAcct.php>
- ❖ The PI of a computing lab may request user accounts for members of his/her computing lab: <http://help.gacrc.uga.edu/userAcct.php>

Connection & Login @ zcluster

- ❖ Open a connection: Open a terminal and `ssh` to your account

```
ssh pakala@zcluster.rcc.uga.edu
```

or

```
ssh -X pakala@zcluster.rcc.uga.edu
```

⁽¹⁾ `-X` is for X windows application running on the cluster to be forwarded to your local machine

⁽²⁾ If using Windows, use `SSH client` to open connection, get from UGA download software page)

- ❖ Logging in: You will be prompted for your **zcluster password**

```
pakala@zcluster.rcc.uga.edu's password:
```

⁽³⁾ On Linux/Mac, when you type in the password, the prompt blinks and does not move)

- ❖ Logging out: `exit` to leave the system

```
pakala@zcluster:~$ exit
```

PUTTY: LOGIN

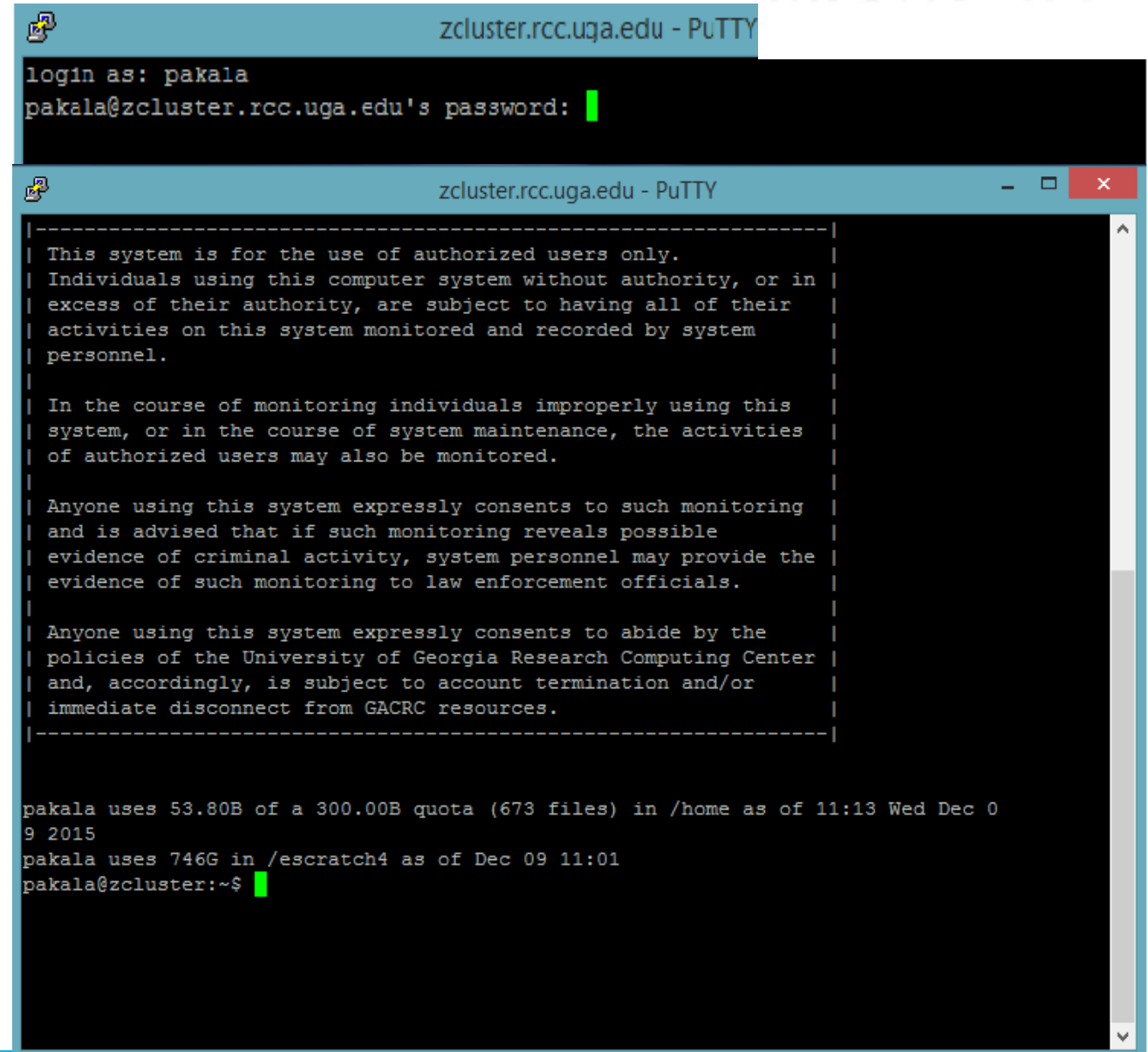
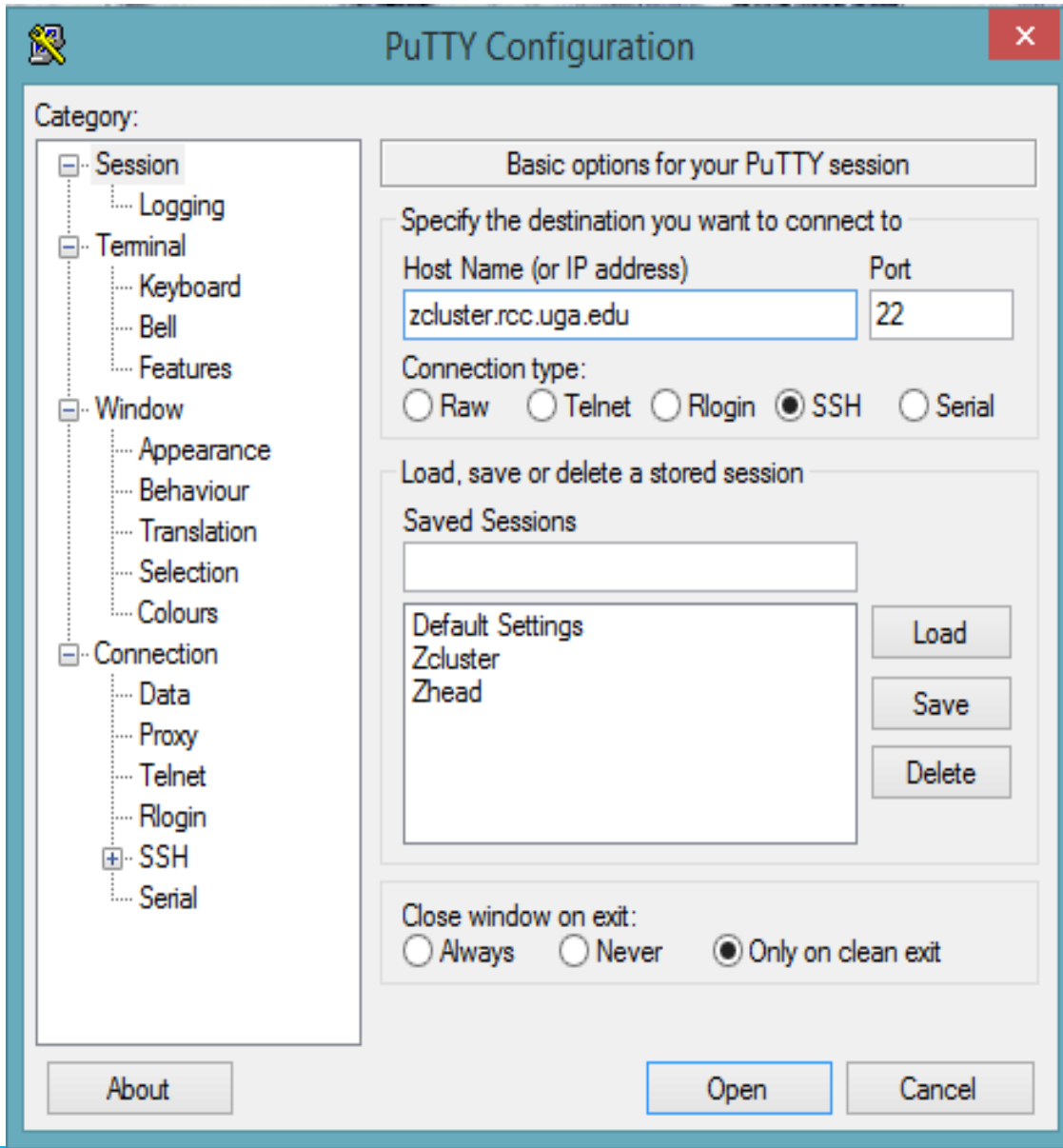

Transfer Files @ zcluster



- ❖ On Linux, Mac or cygwin on Windows : `scp [Source] [Target]`

E.g. 1: On local machine, do Local → zcluster

```
scp file1 username@copy.rcc.uga.edu:~/subdir
```

```
scp *.dat username@copy.rcc.uga.edu:~/subdir
```

E.g. 2: On local machine, do zcluster → Local

```
scp username@copy.rcc.uga.edu:~/subdir/file ./
```

```
scp username@copy.rcc.uga.edu:~/subdir/*.dat ./
```

- ❖ On Windows: **FileZilla**, **WinSCP**, **SSH Secure Client**, etc.

SSH Secure Client: Connecting to COPY Node

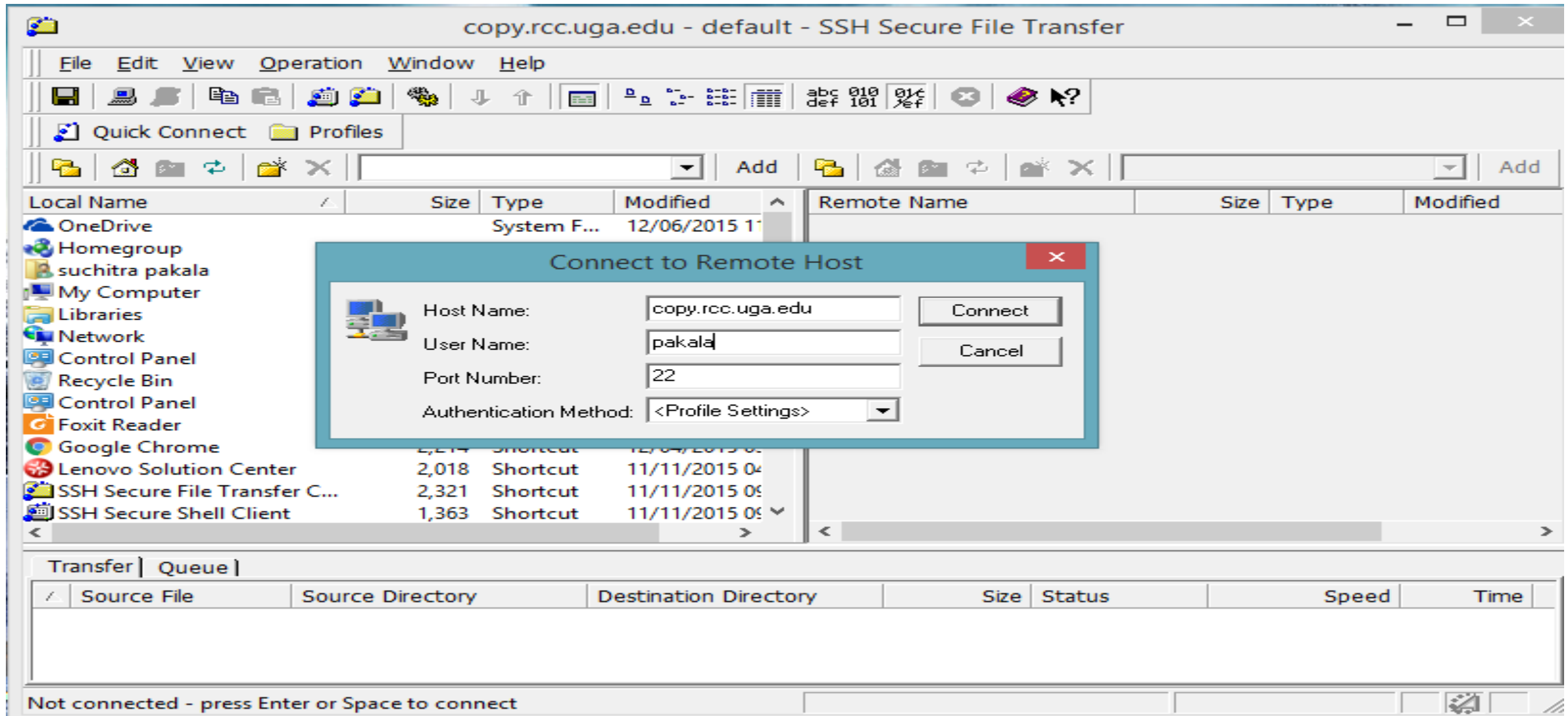

The screenshot displays the SSH Secure File Transfer application window titled "copy.rcc.uga.edu - default - SSH Secure File Transfer". The interface includes a menu bar (File, Edit, View, Operation, Window, Help), a toolbar with various icons, and a main workspace divided into local and remote file views. A "Connect to Remote Host" dialog box is overlaid on the workspace, containing the following fields:

- Host Name: copy.rcc.uga.edu
- User Name: pakala
- Port Number: 22
- Authentication Method: <Profile Settings>

Buttons for "Connect" and "Cancel" are visible in the dialog. The main workspace shows a table of local files and a "Transfer | Queue" section at the bottom.

Local Name	Size	Type	Modified	Remote Name	Size	Type	Modified
OneDrive							
Homegroup							
suchitra pakala							
My Computer							
Libraries							
Network							
Control Panel							
Recycle Bin							
Control Panel							
Foxit Reader							
Google Chrome							
Lenovo Solution Center	2,018	Shortcut	11/11/2015 04				
SSH Secure File Transfer C...	2,321	Shortcut	11/11/2015 09				
SSH Secure Shell Client	1,363	Shortcut	11/11/2015 09				

Transfer | Queue

Source File	Source Directory	Destination Directory	Size	Status	Speed	Time
-------------	------------------	-----------------------	------	--------	-------	------

Not connected - press Enter or Space to connect

SSH Secure Client: Connecting to COPY Node

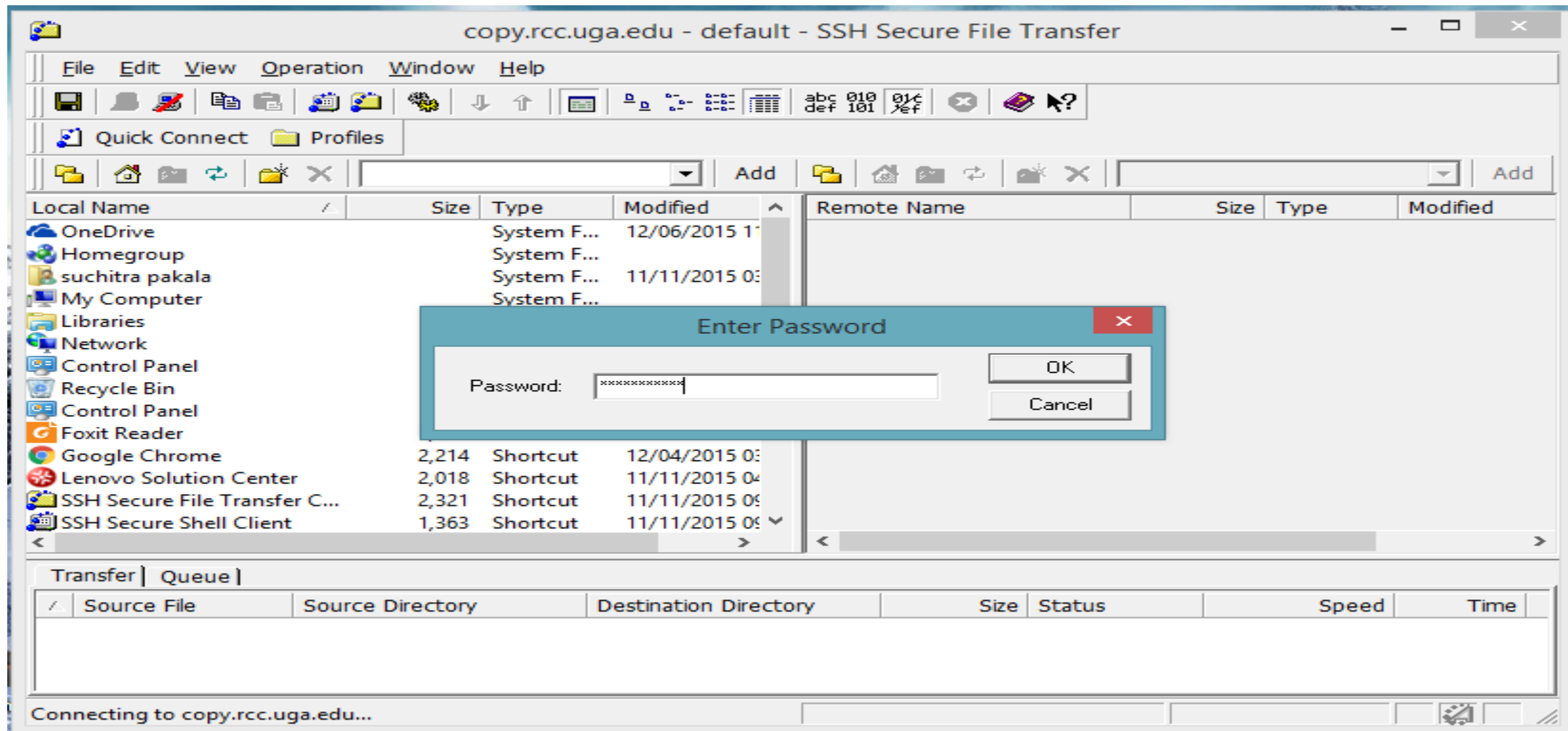

The screenshot shows the SSH Secure File Transfer application window titled "copy.rcc.uga.edu - default - SSH Secure File Transfer". The interface includes a menu bar (File, Edit, View, Operation, Window, Help), a toolbar, and a main workspace divided into local and remote file views. A modal dialog box titled "Enter Password" is overlaid on the workspace, containing a "Password:" label, a text input field with masked characters, and "OK" and "Cancel" buttons. The status bar at the bottom indicates "Connecting to copy.rcc.uga.edu...".

Local Name	Size	Type	Modified	Remote Name	Size	Type	Modified
OneDrive		System F...	12/06/2015 11				
Homegroup		System F...					
suchitra pakala		System F...	11/11/2015 03				
My Computer		System F...					
Libraries							
Network							
Control Panel							
Recycle Bin							
Control Panel							
Foxit Reader							
Google Chrome	2,214	Shortcut	12/04/2015 03				
Lenovo Solution Center	2,018	Shortcut	11/11/2015 04				
SSH Secure File Transfer C...	2,321	Shortcut	11/11/2015 05				
SSH Secure Shell Client	1,363	Shortcut	11/11/2015 05				

Transfer	Queue	Source File	Source Directory	Destination Directory	Size	Status	Speed	Time
----------	-------	-------------	------------------	-----------------------	------	--------	-------	------

SSH Secure : Connected to Home Directory

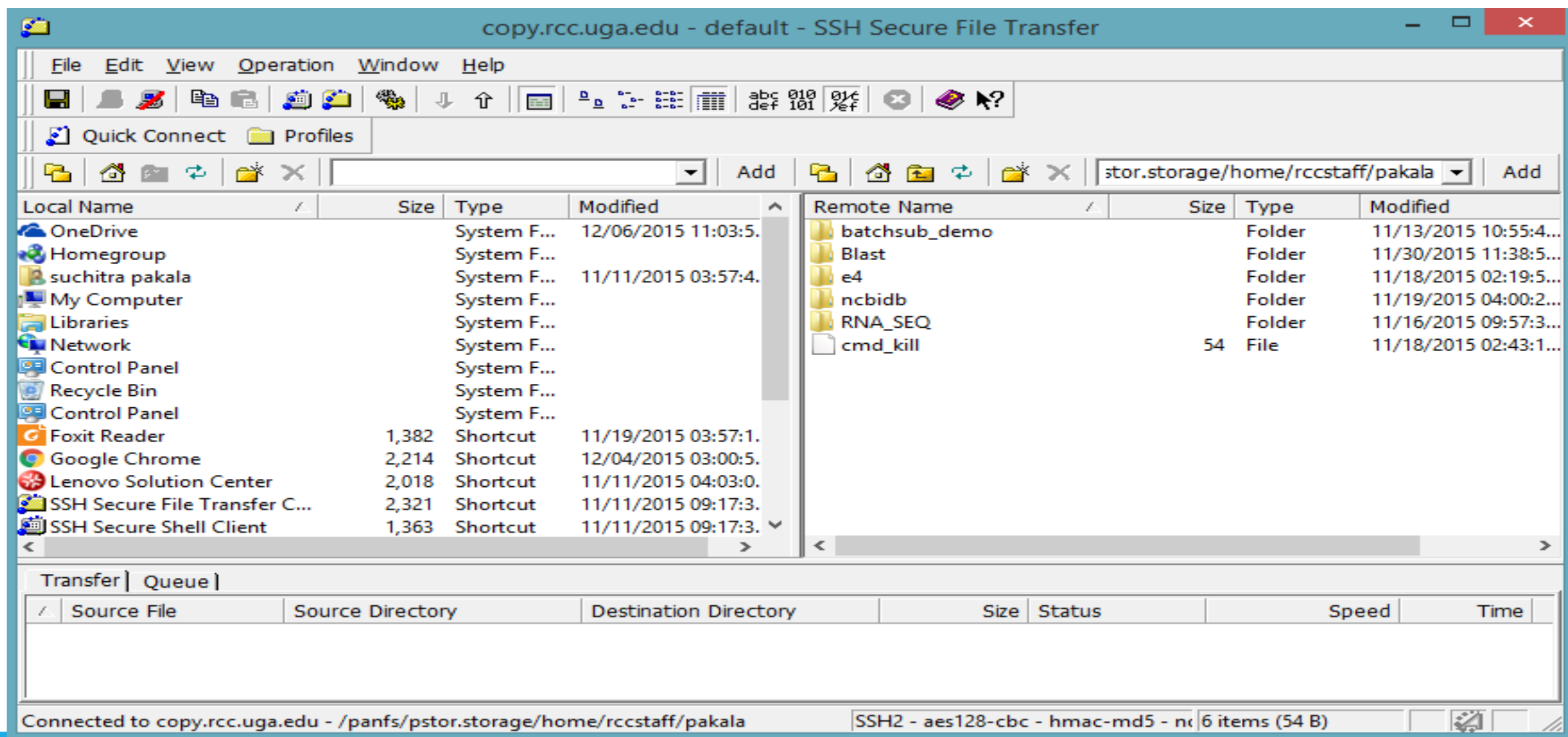

The screenshot displays the SSH Secure File Transfer application window. The title bar reads "copy.rcc.uga.edu - default - SSH Secure File Transfer". The interface is divided into several sections:

- Menu Bar:** File, Edit, View, Operation, Window, Help.
- Toolbar:** Includes icons for file operations like copy, paste, delete, and refresh.
- Quick Connect:** A section with "Quick Connect" and "Profiles" buttons.
- Address Bar:** Shows the current remote path: "stor.storage/home/rccstaff/pakala".
- Local Name Table:** Lists local system folders and shortcuts.
- Remote Name Table:** Lists files and folders on the remote server.
- Transfer Queue:** A table for monitoring file transfers.
- Status Bar:** Shows the connection details: "Connected to copy.rcc.uga.edu - /panfs/pstor.storage/home/rccstaff/pakala" and "SSH2 - aes128-cbc - hmac-md5 - nc 6 items (54 B)".

Local Name	Size	Type	Modified
OneDrive		System F...	12/06/2015 11:03:5...
Homegroup		System F...	
suchitra pakala		System F...	11/11/2015 03:57:4...
My Computer		System F...	
Libraries		System F...	
Network		System F...	
Control Panel		System F...	
Recycle Bin		System F...	
Control Panel		System F...	
Foxit Reader	1,382	Shortcut	11/19/2015 03:57:1...
Google Chrome	2,214	Shortcut	12/04/2015 03:00:5...
Lenovo Solution Center	2,018	Shortcut	11/11/2015 04:03:0...
SSH Secure File Transfer C...	2,321	Shortcut	11/11/2015 09:17:3...
SSH Secure Shell Client	1,363	Shortcut	11/11/2015 09:17:3...

Remote Name	Size	Type	Modified
batchsub_demo		Folder	11/13/2015 10:55:4...
Blast		Folder	11/30/2015 11:38:5...
e4		Folder	11/18/2015 02:19:5...
ncbidb		Folder	11/19/2015 04:00:2...
RNA_SEQ		Folder	11/16/2015 09:57:3...
cmd_kill	54	File	11/18/2015 02:43:1...

Source File	Source Directory	Destination Directory	Size	Status	Speed	Time
-------------	------------------	-----------------------	------	--------	-------	------

SSH Secure : Navigated to /escratch4/pakala

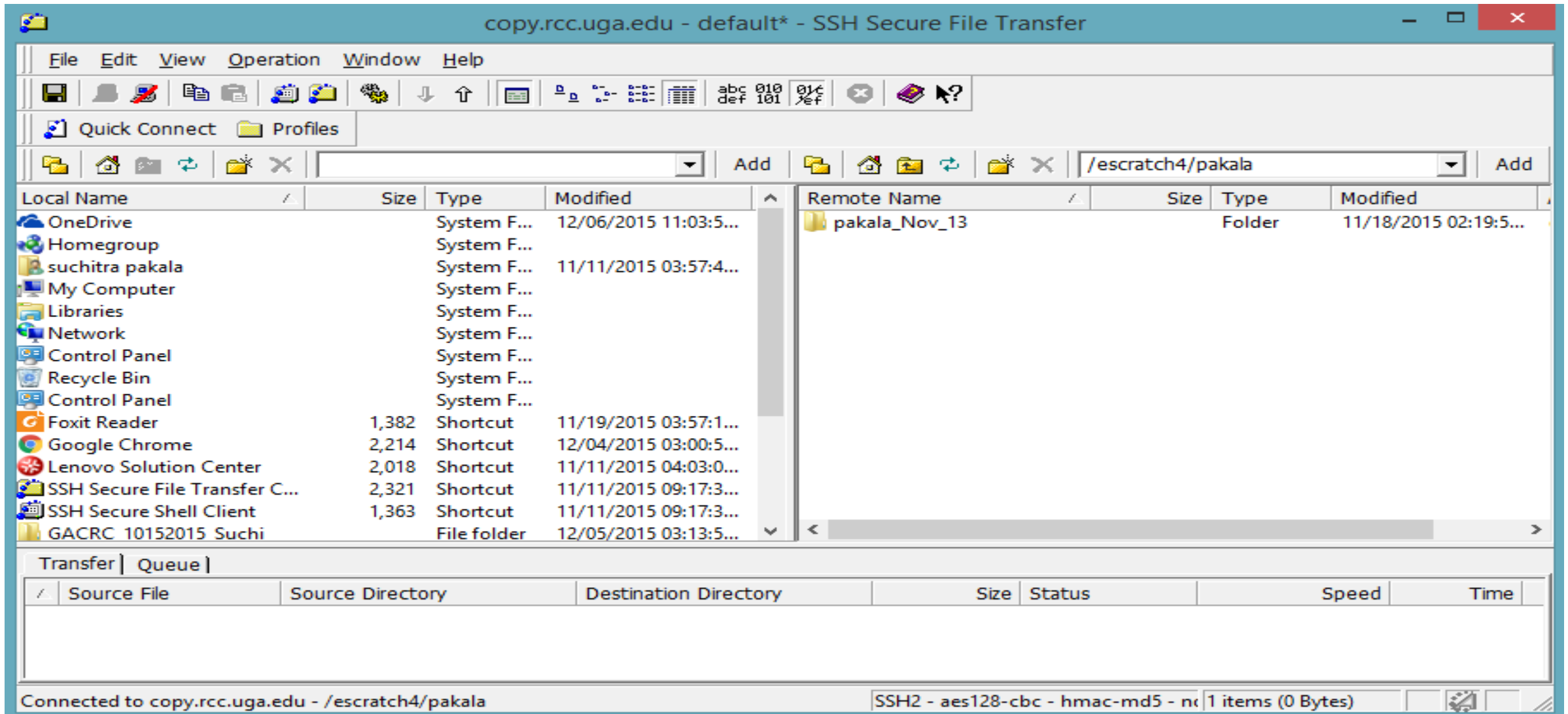

The screenshot shows the SSH Secure File Transfer application window. The title bar reads "copy.rcc.uga.edu - default* - SSH Secure File Transfer". The interface includes a menu bar (File, Edit, View, Operation, Window, Help), a toolbar with various icons, and a "Quick Connect" section with "Profiles". The main area is split into two panes. The left pane shows the local file system with a list of items including OneDrive, Homegroup, suchitra pakala, My Computer, Libraries, Network, Control Panel, Recycle Bin, Foxit Reader, Google Chrome, Lenovo Solution Center, SSH Secure File Transfer C..., SSH Secure Shell Client, and GACRC 10152015 Suchi. The right pane shows the remote directory listing for "/escratch4/pakala", which contains a single folder named "pakala_Nov_13".

Local Name	Size	Type	Modified	Remote Name	Size	Type	Modified
OneDrive		System F...	12/06/2015 11:03:5...	pakala_Nov_13		Folder	11/18/2015 02:19:5...
Homegroup		System F...					
suchitra pakala		System F...	11/11/2015 03:57:4...				
My Computer		System F...					
Libraries		System F...					
Network		System F...					
Control Panel		System F...					
Recycle Bin		System F...					
Control Panel		System F...					
Foxit Reader	1,382	Shortcut	11/19/2015 03:57:1...				
Google Chrome	2,214	Shortcut	12/04/2015 03:00:5...				
Lenovo Solution Center	2,018	Shortcut	11/11/2015 04:03:0...				
SSH Secure File Transfer C...	2,321	Shortcut	11/11/2015 09:17:3...				
SSH Secure Shell Client	1,363	Shortcut	11/11/2015 09:17:3...				
GACRC 10152015 Suchi		File folder	12/05/2015 03:13:5...				

Transfer | Queue |

Source File	Source Directory	Destination Directory	Size	Status	Speed	Time
-------------	------------------	-----------------------	------	--------	-------	------

Connected to copy.rcc.uga.edu - /escratch4/pakala

SSH2 - aes128-cbc - hmac-md5 - no compression | 1 items (0 Bytes)

Run Interactive Jobs @ zcluster

- ❖ To run an interactive job, you need to open a session on an **interactive node** using **qlogin** command:

```

pakala@zcluster:~$ qlogin
Your job 9559204 ("QLOGIN") has been submitted
waiting for interactive job to be scheduled ...
Your interactive job 9559204 has been successfully scheduled.
...
compute-14-7.local$ ← Now I am on compute-14-7, which is an interactive node
  
```

- ❖ Current maximum runtime is **12** hours
- ❖ When you are done, remember to **exit** the session! 
- ❖ Detailed information, about interactive parallel jobs.
https://wiki.gacrc.uga.edu/wiki/Running_Jobs_on_zcluster

Submit Batch Jobs @ zcluster

- ❖ Components you need to submit a batch job:
 - ❖ **Software** already installed on zcluster
 - ❖ **Job submission script** to run the software,
 - ✓ Specifying working directory
 - ✓ Exporting environment variables, e.g.,
 - OMP_NUM_THREADS (OpenMP threads number)
 - LD_LIBRARY_PATH (searching paths for shared libraries)
- ❖ Common commands you need:
 - ❖ **qsub** with specifying **queue name, threads or MPI rank number**
 - ❖ **qstat, qdel**
 - ❖ **qacct, qsj**, etc.

Batch *Serial* Job @ zcluster

Step 1: Create a job submission script `fastqc_sub.sh` running Fastqc tool:

```
#!/bin/bash
```

→ Linux shell (**bash**)

```
cd /escratch4/pakala/pakala_Nov_13
```

→ Specify and enter (**cd**) the working directory

```
export PATH=/usr/local/fastqc/latest:${PATH}
```

→ Export command helps to set the Environment variables

```
time fastqc SRR1369670.fastq -o Output_File
```

→ Run **Fastqc** with 'time' command to measure amount of time it takes to run the application

Step 2: Submit it to the queue:

```
$qsub -q rcc-30d fastqc_sub.sh
```

OR

```
$qsub -q rcc-30d -l mem_total=20g fastqc_sub.sh
```

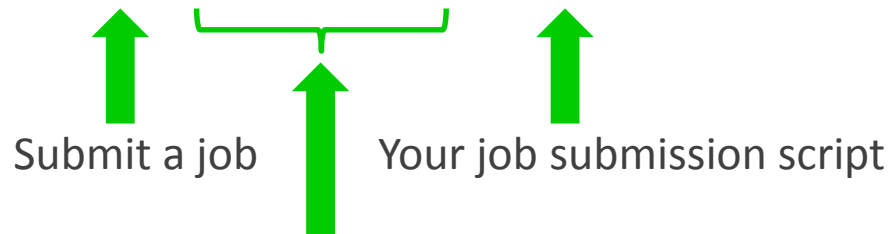

to the queue rcc-30d
with **16GB** RAM/Node

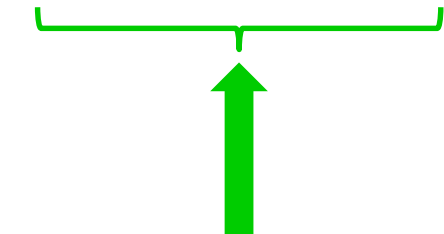

to the queue rcc-30d
with **48GB** RAM/Node

Batch *Threaded* Job @ zcluster

- ❖ **Step 1:** Create a job submission script `blast.sh` running Blast:

```
#!/bin/bash

cd /escratch4/pakala/pakala_Nov_13

time /usr/local/ncbiblast/latest/bin/blastall -p 2 [options] → Run Blastall with 2 threads
```

- ❖ **Step 2:** Submit it to the queue:

```
$ qsub -q rcc-30d -l mem_total=20g -pe thread 2 ./blast.sh
```

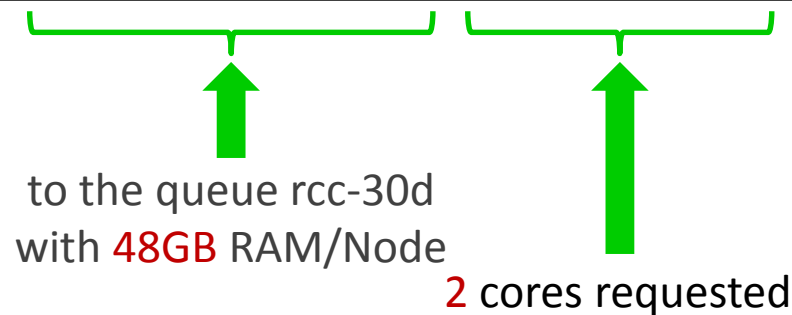

 to the queue `rcc-30d`
 with **48GB** RAM/Node

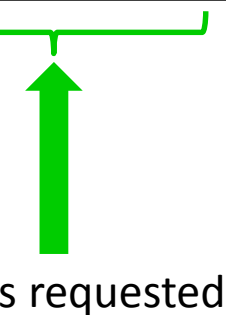

2 cores requested

Number of Threads =
Number of Cores Requested

Note:
Please use the `rcc-mc-30d` queue,
If using threads **more than 8!**

Batch *MPI* Job @ zcluster

- ❖ **Step 1:** Create a job submission script *sub.sh* running RAxML:

```
#!/bin/bash
cd /escratch4/pakala/pakala_Nov_13
```

```
export MPIRUN=/usr/local/mpich2/1.4.1p1/gcc 4.5.3/bin/mpirun
```

→ Define and export environment variable (*MPIRUN*) for convenient usage

```
$MPIRUN -np $NSLOTS /usr/local/raxml/latest/raxmlHPC-MPI-SSE3 [options]
```

→ Run *RAxML* with 20 MPI processes (*-np \$NSLOTS*)

- ❖ **Step 2:** Submit it to the queue:

```
$ qsub -q rcc-30d -pe mpi 20 sub.sh
```

20 cores requested,
\$NSLOTS will be assigned to 20 automatically, before
the job submission script is interpreted

Check and Cancel Jobs @ zcluster

- ❖ To check the status of all queued and running jobs: **qstat**

```

qstat           → shows your job in the pool
qstat -u "*"    → shows all the jobs in the pool
qstat -j 12345  → shows detailed information, e.g., maxvmem, about the job with JOBID 12345
qstat -g t      → list all nodes used by your jobs
  
```

- ❖ To cancel a queued or running job: **qdel**

```

qdel -u pakala → deleted all your jobs
qdel 12345     → deletes your job with JOBID 12345
  
```

- ❖ To list detailed information about a job: **qsj**, **qacct**

```

qsj 12345      → shows information, e.g., maxvmem, about the RUNNING job with JOBID 12345
qacct -j 12345 → shows information, e.g., maxvmem, about the ENDED job with JOBID 12345
  
```

Software Installed @ zcluster

- ❖ Perl, Python, Java, awk, sed, C/C++ and Fortran compilers
- ❖ Matlab, Maple, R
- ❖ Many Bioinformatics applications: NCBI Blast+, Velvet, Trinity, TopHat, MrBayes, SoapDeNovo, Samtools, RaxML, etc.
- ❖ RCCBatchBlast (RCCBatchBlastPlus) to distribute NCBI Blast (NCBI Blast+) searches to multiple nodes.
- ❖ Many Bioinformatics Databases: NCBI Blast, Pfam, uniprot, etc.
https://wiki.gacrc.uga.edu/wiki/Bioinformatics_Databases
- ❖ For a complete list of applications: <https://wiki.gacrc.uga.edu/wiki/Software>

How to Submit Tickets to GACRC



- ❖ For Installation/Downloading Software:
 - ❖ User needs to provide the name, version (or latest), and website
 - ❖ Applications need to be compatible with Linux
 - ❖ **Note** – only **FREE** software will be installed
- ❖ For Troubleshooting:
 - ❖ List the path of the working directory, path of the script that is producing errors, Job ID, and the command sent to the queue or interactive node
 - ❖ No need to attach the script or huge error messages
- ❖ For Testing:
 - ❖ Please have a sample dataset at your working directory, so that it can be used for debugging
- ❖ These steps will help us in responding quickly and efficiently

THANK YOU for your
patience



Questions?

A solid blue horizontal bar at the bottom of the slide.